

## 2MP Fixed Dual-light Turret Network Camera

### IPC-T132-AF28-DL-ECO



## Features

- High quality image with 1080P, 1/3.0" CMOS sensor
- 1080P (1920 × 1080)@30 fps; 720P (1280 × 720)@30 fps
- Ultra 265, H.265, H.264
- 2D/3D DNR (digital noise reduction)
- ROI (region of interest) ensures image quality in areas of interest with low bandwidth
- Smart IR, up to 30 m (98.4 ft.) IR distance
- 3-axis
- Built-in mic
- Wide temperature range: -30 °C to 60 °C (-22 °F to 140 °F)
- Supports PoE power supply
- IP67

## Specifications

Model	IPC-T132-AF28-DL-ECO
<b>Camera</b>	
Max Resolution	2 MP
Sensor	1/3.0" CMOS
Min. Illumination	Color: 0.005 Lux (F1.6, AGC ON), 0 Lux with IR on
Day/Night	IR-cut filter with auto switch (ICR)
Shutter	Auto/Manual, 1 to 1/100000 s
Adjustment Angle	Pan: 0° to 360°, Tilt: 0° to 80°, Rotate: 0° to 360°
S/N	> 52 dB
WDR	DWDR
<b>Lens</b>	
Focal Length	2.8 mm
Iris	F1.6
Field of View (H)	85.1°
Field of View (V)	46.6°
Field of View (D)	95.5°
<b>DORI</b>	
DORI Distance (Lens)	2.8 mm
DORI Distance (Detect)	51.4 m (168.7 ft.)
DORI Distance (Observe)	20.6 m (67.5 ft.)
DORI Distance (Recognize)	10.3 m (33.8 ft.)
DORI Distance (Identify)	5.1 m (16.9 ft.)
<b>Illuminator</b>	
Supplemental Light	Dual light
Illumination Distance (IR)	30 m (98.4 ft.)
Illumination Distance (Warm Light)	15 m (49.2 ft.)
Wavelength	850 nm
IR On/Off Control	Auto/Manual
<b>Video</b>	
Video Compression	Ultra 265, H.265, H.264
H.264 Code Profile	Baseline profile, Main profile, High profile
Frame Rate	Main Stream: 1080P (1920 × 1080), max. 30 fps; 720P (1280 × 720), max. 30 fps; Sub Stream: 640 × 360, max. 30 fps; 2CIF (704 × 288), max. 30 fps; CIF (352 × 288), max. 30 fps;
Video Bit Rate	128 Kbps to 6144 Kbps
U-code	Support
OSD	Up to 4 OSDs
Privacy Mask	Up to 4 areas
ROI	Up to 8 areas
Video Stream	Dual streams







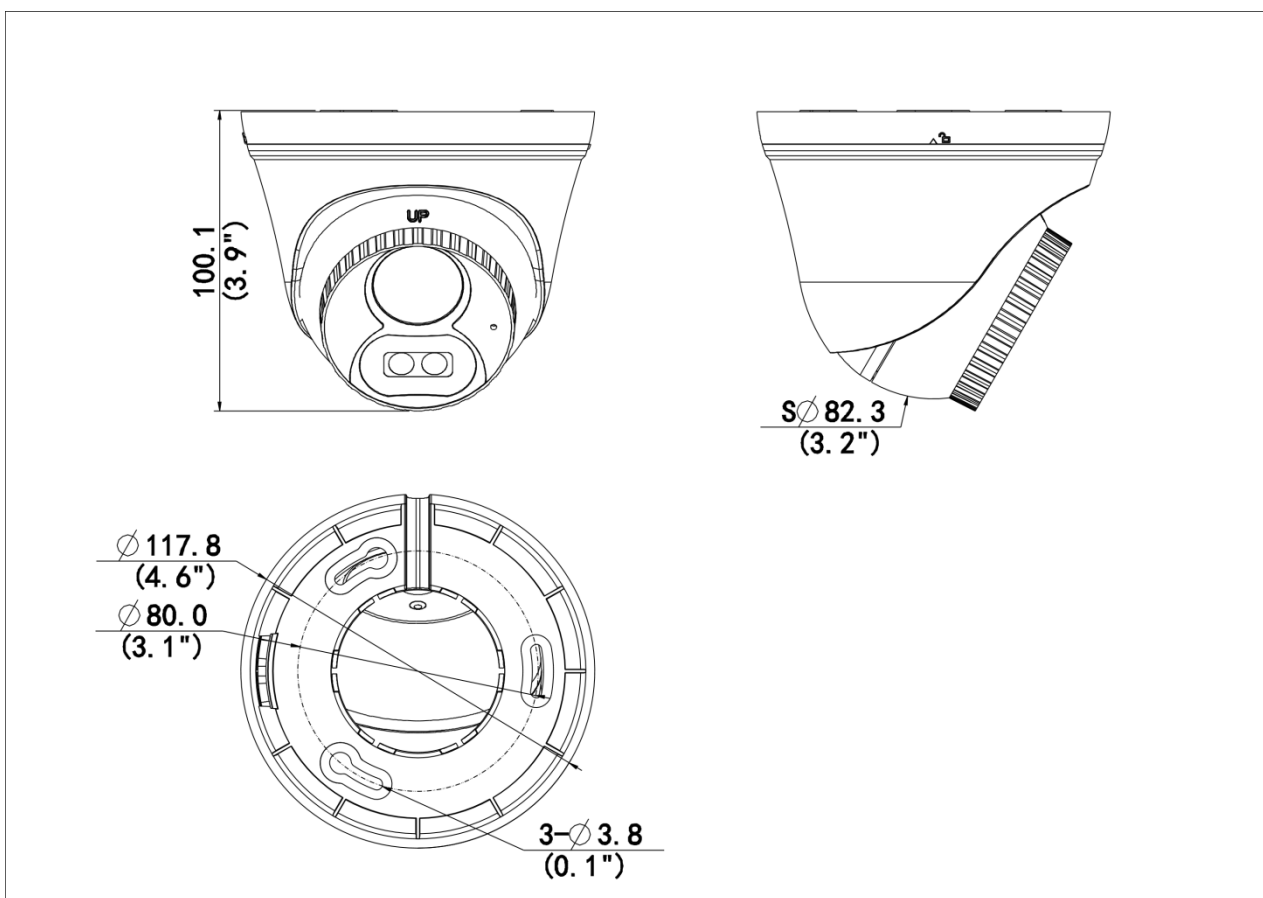



Image	
White Balance	Auto, Outdoor, Fine tune, Sodium lamp, Locked, Auto2
Digital Noise Reduction	2D/3D DNR
Smart IR	Support
Flip	Normal, Flip vertical, Flip horizontal, 180°
Dewarping	N/A
HLC	Support
BLC	Support
Defog	Digital defog
Events	
Basic Detection	Motion detection, Audio detection, Human body detection 2.0
General Function	Watermark, IP address filtering, Access policy, ARP protection, RTSP authentication, User authentication, HTTP authentication
Audio	
Audio Compression	G.711U, G.711A
Audio Bitrate	64 Kbps
Two-way Audio	N/A
Suppression	Support
Sampling Rate	8 kHz
Network	
Protocols	IPv4, IGMP, ICMP, ARP, TCP, UDP, DHCP, RTP, RTSP, DNS, DDNS, NTP, UPnP, HTTP, QoS, RTCP, RTMP
Compatible Integration	ONVIF (Profile S, Profile T) , API, SDK
User/Host	Up to 32 users. 2 user levels: administrator and common user
Client	APP, Uniarch client
Web Browser	Plug-in free live view: Chrome 57+, Firefox 58+, Edge 16+
Interface	
Audio I/O	N/A
Alarm I/O	N/A
Built-in Mic	Support
Built-in Speaker	N/A
WIFI	N/A
Network	1 × RJ45 10 M/100 M Base-TX Ethernet
Video Output	N/A
Certification	
EMC	CE-EMC (EN 55032, EN 61000-3-3, EN IEC 61000-3-2, EN 55035) FCC (FCC 47 CFR part15 B)
Safety	CE LVD (EN 62368-1)
Environment	CE-RoHS (2011/65/EU;(EU)2015/863); WEEE (2012/19/EU);
Protection	IP67 (IEC 60529)
General	
Power	PoE (IEEE 802.3af)
Power Consumption	Max. 3.5 W

Power Interface	N/A
Dimensions	Ø118 mm × 100 mm (Ø4.6" × 3.9") (Ø × H)
Weight	0.19 kg (0.42 lb.)
Material	Graphene + Plastic
Working Environment	-30 °C to 60 °C (-22 °F to 140 °F), Humidity: ≤ 95% RH (non-condensing)
Storage Environment	-30 °C to 60 °C (-22 °F to 140 °F), Humidity: ≤ 95% RH (non-condensing)
Surge Protection	4 KV
Reset Button	N/A
Web Client Language	1 Language: English

## Dimensions



## Accessories

<p><b>TR-JB03-I-IN</b> Junction Box for Turret Camera(Support wiring from behind)</p>	<p><b>TR-A01-IN</b> NPT 3/4" Waterproof Cable Gland</p>	<p><b>TR-UP06-IN</b> Universal Pole Mounting Bracket</p>
		
<p><b>TR-WM07P-B</b> Dome Wall Mounting Plastic Bracket</p>	<p><b>TR-SM05-IN</b> Switch Box Adapter for Fixed Dome</p>	<p><b>TR-CM24-IN</b> Dome Pendant Mounting Bracket(Indoor)</p>
		
<p><b>TR-SE24-IN</b> Dome Pendant Mounting Pole 200mm</p>	<p><b>TR-SE24-A-IN</b> Dome Pendant Mounting Pole 500mm</p>	<p><b>TR-JB07/WM03-G-IN-V2</b> Wall Mounting Assembling Bracket For 32 Fix-dome&amp;Mini Fix-dome&amp;Plastic Turret Camera</p>
		
<p><b>TR-WM03-D-IN-V2</b> Wall Mounting Bracket for 32 Fix-dome&amp;Mini Fix-dome&amp;Plastic Turret Camera</p>	<p><b>TR-UC08-C-V2</b> Bullet&amp;Dome Corner Mounting Bracket</p>	
		

### Zhejiang Uniview Technologies Co., Ltd.



<http://www.uniview.com>



[overseasbusiness@uniview.com](mailto:overseasbusiness@uniview.com); [globalsupport@uniview.com](mailto:globalsupport@uniview.com)



No. 369, Xietong Road, Xixing Sub-district, Binjiang District, Hangzhou City, 310051, Zhejiang Province, China



©2023-2025 Zhejiang Uniview Technologies Co., Ltd. All rights reserved.

\*Product specifications and availability are subject to change without notice.

\*Despite our best efforts, technical or typographical errors may exist in this document.

Uniview cannot be held responsible for any such errors and reserves the right to change the contents of this document without prior notice.