

# 5MP HD Wide Angle Intelligent IR Fixed Eyeball Network Camera IPC3605SB-ADF16KM-IO

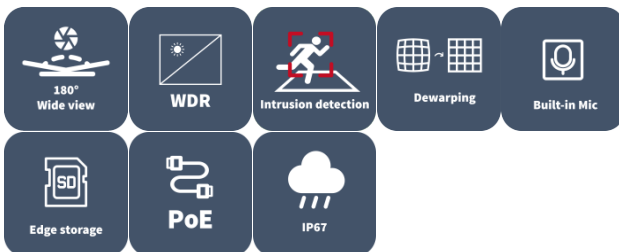

## Features

- High quality image with 5 MP, 1/2.7" CMOS sensor
- 5 MP (2880 × 1620)@30/25 fps; 4 MP (2560 × 1440)@30/25 fps; 3 MP (2304 × 1296)@30/25 fps; 1080P (1920 × 1080)@30/25 fps
- Wide angle technology realizes the horizontal viewing angle of 180°
- The dewarp level can be configured in the range of 1 to 9
- Ultra 265, H.265, H.264, MJPEG
- Smart intrusion prevention, including cross line, intrusion, enter area, leave area detection
- Intelligent intrusion prevention system based on target classification significantly reduces false alarms caused by leaves, birds, and lights, accurately focusing on humans, vehicles, and non-motor vehicles
- 120 dB true WDR technology enables clear image in strong light scene
- Built-in mic
- Smart IR, up to 20 m (65.6 ft.) IR distance
- MicroSD, up to 512 GB
- IP67 protection
- IK10 vandal resistant

## Specifications

Model	IPC3605SB-ADF16KM-IO
<b>Camera</b>	
Max Resolution	5 MP
Sensor	1/2.7" CMOS
Min. Illumination	Color: 0.01 Lux (F2.0, AGC ON), 0 Lux with IR on
Day/Night	IR-cut filter with auto switch (ICR)
Shutter	Auto/Manual, 1 ~ 1/100000s
Adjustment Angle	Pan: 0° to 360°, Tilt: 0° to 75°, Rotate: 0° to 360°
S/N	>52 dB
WDR	120 dB
<b>Lens</b>	
Focal Length	1.68 mm
Field of View (H)	180°
Iris Type	Fixed
Iris	F2.0
Field of View (V)	100°
Field of View (D)	180°
Lens Type	Fixed
<b>DORI</b>	
DORI Distance (Lens)	1.68 mm
DORI Distance (Detect)	37.8 m (124.0 ft.)
DORI Distance (Observe)	15.1 m (49.6 ft.)
DORI Distance (Recognize)	7.6 m (24.9 ft.)
DORI Distance (Identify)	3.8 m (12.5 ft.)
<b>Illuminator</b>	
Supplemental Light	IR
Illumination Distance (IR)	20 m (65.6 ft.)
IR On/Off Control	Auto/Manual
Wavelength	850 nm
<b>Video</b>	
Video Compression	Ultra 265, H.265, H.264, MJPEG
Frame Rate	Main Stream: 5 MP (2880 × 1620), max. 30 fps; 4 MP (2560 × 1440), max. 30 fps; 3 MP (2304 × 1296), max. 30 fps; 1080P (1920 × 1080), max. 30 fps; 1280 × 720 max. 30 fps Sub Stream: 1080P (1920 × 1080), max. 30 fps; 720P (1280 × 720), max. 30 fps; D1 (720 × 576), max. 30 fps; 640 × 360, max. 30 fps; 2CIF (704 × 288), max. 30 fps; CIF (352 × 288), max. 30 fps; Third Stream: D1 (720 × 576), max. 30 fps; 640 × 360, max. 30 fps; 2CIF (704 × 288), max. 30 fps; CIF (352 × 288), max. 30 fps;
H.264 Code Profile	Baseline profile, Main profile, High profile
Video Bit Rate	128 Kbps to 16 Mbps
U-code	Support
OSD	Up to 8 OSDs





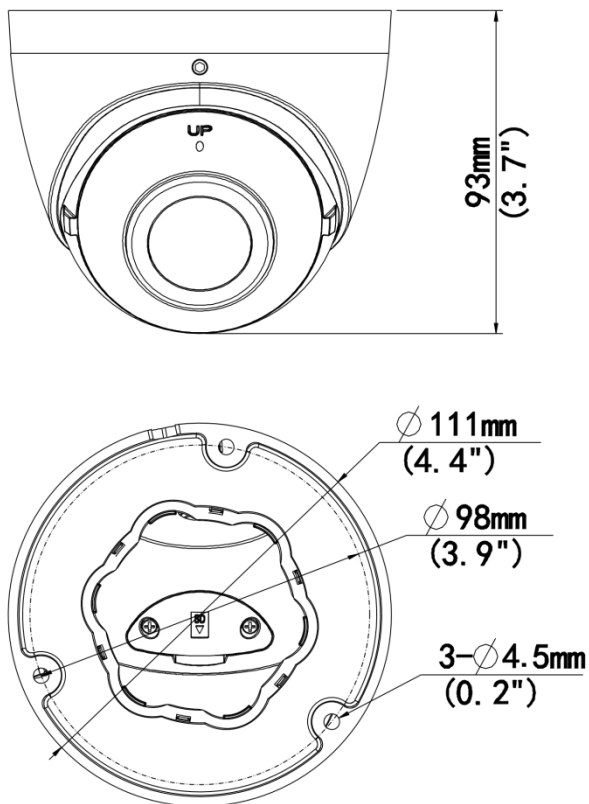

Privacy Mask	Up to 4 areas
ROI	Support
Video Stream	Triple streams
<b>Image</b>	
White Balance	Auto, Outdoor, Fine tune, Sodium lamp, Locked, Auto2
Smart IR	Support
Digital Noise Reduction	2D/3D DNR
Flip	Normal, Flip vertical, Flip horizontal, 180°
Dewarping	Support
HLC	Support
BLC	Support
Defog	Digital defog
<b>Intelligent</b>	
Smart Intrusion Prevention	Cross line detection, intrusion detection, enter area detection, leave area detection (support false alarm filtering and the classification of human, non-motor vehicle and vehicle)
<b>Events</b>	
Basic Detection	Motion detection, Ultra motion detection, Tampering alarm, Audio detection
General Function	Watermark, IP address filtering, Access policy, ARP protection, RTSP authentication, User authentication, HTTP authentication
<b>Audio</b>	
Audio Compression	G.711U, G.711A, AAC-LC
Audio Bitrate	G.711U/G.711A: 64 kbps, AAC-LC: 128 kbps
Two-way Audio	N/A
Suppression	Support
Sampling Rate	G.711U/G.711A: 8 kHz, AAC-LC: 8 kHz, 16 kHz, 48 kHz
<b>Storage</b>	
Edge Storage	MicroSD, up to 512 GB
Network Storage	ANR, NAS (NFS)
<b>Network</b>	
Protocols	IPv4, IPv6, IGMP, ARP, TCP, UDP, DHCP, PPPoE, RTP, RTSP, RTCP, RTMP, DNS, DDNS, NTP, FTP, HTTP, HTTPS, SMTP, 802.1x, SNMP, QoS
Compatible Integration	ONVIF (Profile S, Profile G, Profile T, Profile M), API, SDK
User/Host	Up to 32 users. 3 user levels: administrator, common user and operator
Security	Password Protection, Strong Password, HTTPS Encryption, Export Operation Logs, Basic and Digest Authentication for RTSP, Digest Authentication for HTTP, TLS 1.2, WSSE and Digest Authentication for ONVIF
Client	EZStation, APP
Web Browser	Plug-in required live view: IE 10+, Chrome 45+, Firefox 52+, Edge 79+, Plug-in free live view: Chrome 57+, Firefox 58+, Edge 16+
<b>Interface</b>	
Audio I/O	N/A
Alarm I/O	N/A
Serial Port	N/A

Built-in Mic	Support
Built-in Speaker	N/A
WIFI	N/A
Network	1 × RJ45 10 M/100 M Base-TX Ethernet
Video Output	N/A
<b>Certification</b>	
EMC	CE-EMC (EN 55032, EN 61000-3-3, EN IEC 61000-3-2, EN 55035) FCC (FCC 47 CFR part15 B)
Safety	CE LVD (EN 62368-1) CB (IEC 62368-1) UL/CUL (UL 62368-1, CAN/CSA C22.2 No. 62368-1)
Environment	CE-RoHS (2011/65/EU;(EU)2015/863); WEEE (2012/19/EU);
Protection	IP67 (IEC 60529) IK10 (IEC 62262)
<b>General</b>	
Power	DC 12 V±25%, PoE (IEEE 802.3af)
Power Consumption	Max. 5.5 W
Power Interface	Ø5.5 mm coaxial power plug
Dimensions	Ø111 mm × 93 mm (Ø4.4" × 3.7") (Ø × H)
Weight	0.48 kg (1.06 lb.)
Material	Metal
Working Environment	-30 °C to 60 °C (-22 °F to 140 °F), Humidity: ≤ 95% RH (non-condensing)
Storage Environment	-30 °C to 60 °C (-22 °F to 140 °F), Humidity: ≤ 95% RH (non-condensing)
Surge Protection	4 KV
Reset Button	Support
Web Client Language	20 Languages: Traditional Chinese, English, Simplified Chinese, Polish, German, Russian, French, Korean, Dutch, Czech, Portuguese (Europe), Portuguese (Brazil), Japanese, Thai, Turkish, Spanish (Latin America), Spanish (Europe), Hungarian, Italian, Vietnamese

## Dimensions



## Accessories

<p><b>TR-JB03-G-IN</b> Junction Box for Mini Fix-dome(Support wiring from behind)</p>	<p><b>TR-A01-IN</b> NPT 3/4" Waterproof Cable Gland</p>	<p><b>TR-SE24-IN</b> Dome Pendent Mounting Pole 200mm</p>
		
<p><b>TR-SE24-A-IN</b> Dome Pendent Mounting Pole 500mm</p>	<p><b>TR-CM24-IN</b> Dome Pendent Mounting Bracket(Indoor)</p>	<p><b>TR-JB07/WM03-G-IN-V2</b> Wall Mounting Assembling Bracket For 32 Fix-dome&amp;Mini Fix-dome&amp;Plastic Turret Camera</p>
		

<b>TR-WM03-D-IN-V2</b> Wall Mounting Bracket for 32 Fix-dome&Mini Fix-dome&Plastic Turret Camera	<b>TR-UC08-C-V2</b> Bullet&Dome Corner Mounting Bracket	<b>TR-UP06-C-IN-V2</b> Pole Mounting Bracket for Bullet Junction Box Only
		

# Unlimited New View

## Zhejiang Uniview Technologies Co., Ltd.

 <http://www.uniview.com>

 [overseasbusiness@uniview.com](mailto:overseasbusiness@uniview.com); [globalsupport@uniview.com](mailto:globalsupport@uniview.com)

 No. 369, Xietong Road, Xixing Sub-district, Binjiang District, Hangzhou City, 310051, Zhejiang Province, China



©2023-2025 Zhejiang Uniview Technologies Co., Ltd. All rights reserved.

\*Product specifications and availability are subject to change without notice.

Despite our best efforts, technical or typographical errors may exist in this document. Uniview cannot be held responsible for any such errors and reserves the right to change the contents of this document without prior notice.