

## 2MP ColorHunter Fixed Warm Light Bullet Analog Camera UAC-B112-F28 (40) -W-X



### Overview

UAC-B112-F28(40)-W-X is a 2MP ColourHunter HD Fixed Mini Bullet Analog Camera with a high-performance 1/3-inch CMOS sensor. It supports TVI/AHD/CVI/CVBS, which effectively enhances product adaptability and diversity of networking solutions. With SYV-75-3 or other coaxial cable types the camera can achieve low-cost, long-distance, anti-interference, and low delay mega-pixel HD video transmission. The camera provides 24/7 color images.

### Features

- 2MP high quality image
- TVI/AHD/CVI/CVBS
- Supports white light illumination, 24/7 color images
- Supports 180° horizontal flip, 180° vertical flip
- OSD configuration menu, easy to operate
- IP67 waterproof and dustproof design, high reliability
- OSD configuration menu in 11 languages
- 3D noise reduction technology delivers clean and sharp images

# Specifications





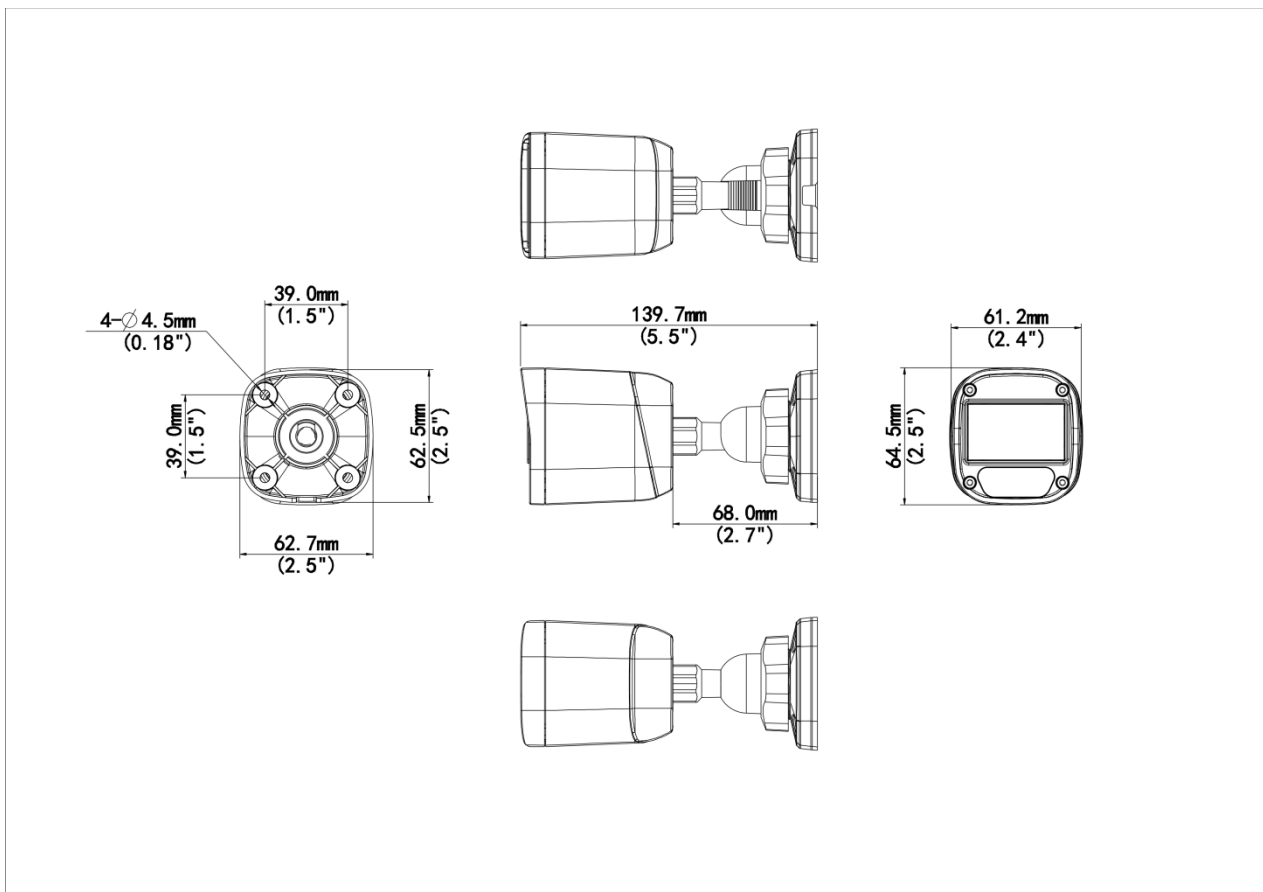

Model	UAC-B112-F28-W-X	UAC-B112-F40-W-X
<b>Camera</b>		
Max Resolution	2 MP	
Sensor Size	1/3.0" CMOS	
Min. Illumination	0.01 lux (F1.6, AGC ON) 0 lux (white light on)	
<b>Lens</b>		
Focus	2.8 mm	4.0 mm
Lens Mount	M12	
Angle of View (H)	100.9°	82.5°
Angle of View (V)	56.5°	42.1°
Angle of View (D)	121.8°	98.6°
<b>Illuminator</b>		
Illuminator Number	One white-light illuminator	
Illumination Distance	20m	
Lifetime	≥ 60000 hours	
<b>Video</b>		
Resolution	1080P: 1920(H)×1080(V) 720P: 1280(H) ×720(V)	
Frame Rate	TVI: 1080P@25fps (default), 1080P@30fps; 720P@25fps, 720P@30fps AHD: 1080P@25fps, 1080P@30fps; 720P@25fps, 720P@30fps CVI: 1080P@25fps, 1080P@30fps; 720P@25fps, 720P@30fps CVBS: PAL, NTSC	
Shutter Time	PAL: 1/25 s-1/50000 s, NTSC: 1/30 s-1/50000 s	
<b>Image</b>		
Exposure Mode	Four modes: Global (default), BLC, HLC, DWDR	
Day/Night	24/7 color images	
Digital Noise Reduction	2D/3D	
White Balance	Two modes: Auto (default), Manual	
WDR	DWDR	
Flip	Supports 180°horizontal flip, 180°vertical flip	
<b>Interface</b>		
Power Interface	5.5 mm Power Interface	
Video Output	BNC, supports TVI/AHD/CVI/CVBS	
<b>Operating Environment</b>		
Temperature	-30 °C to 60 °C (-22 °F to 140 °F)	
Humidity	≤ 95% RH (non-condensing)	
Surge Protection	4 KV for power, 4 KV for video output interfaces	
<b>General</b>		
Power	DC 12 V±25%	
Power Consumption	MAX 2.0W	

Mount	Corner Mount, Pole Mount
Dimensions	142mm*63mm*65mm (L*W*H)
Material	Graphene + Plastic
Weight	145g(0.32lb)
OSD Menu Language	11 Languages: English, German, Spanish (Latin America), French, Italian, Japanese, Korean, Polish, Portuguese (Brazil), Russian, Turkish
<b>Certification</b>	
EMC	CE-EMC (EN 55032, EN 61000-3-3, EN IEC 61000-3-2, EN 55035), FCC (FCC 47 CFR part15 B)
Safety	CE-LVD (EN 62368-1)
Environment	CE-RoHS (2011/65/EU; (EU) 2015/863); WEEE (2012/19/EU)
Protection	IP67 (IEC 60529)

## Dimensions



# Accessories

<p><b>TR-JB05-A-IN</b> Small Bullet Junction Box(Support wiring from behind,Square)</p>	<p><b>TR-UP06-B-IN</b> Bullet Pole Mounting Bracket</p>	<p><b>TR-A01-IN</b> NPT 3/4" Waterproof Cable Gland</p>
		
<p><b>TR-UP06-C-IN-V2</b> Pole Mounting Bracket for Bullet Junction Box Only</p>	<p><b>TR-UC08-C-V2</b> Bullet&amp;Dome Corner Mounting Bracket</p>	<p><b>PWR-DC1201A-UK</b> DC12V/1A Wall Plug British Standard Power Adapter</p>
		
<p><b>PWR-DC1201B-UK</b> UNV DC12V/1A Wall Plug British Standard Power Adapter(Colorful Bag)</p>	<p><b>PWR-DC1201A-US</b> DC12V/1A Wall Plug American Standard Power Adapter</p>	<p><b>PWR-DC1201B-US</b> UNV DC12V/1A Wall Plug American Standard Power Adapter(Colorful Bag)</p>
		
<p><b>PWR-DC1201A-EU</b> DC12V/1A Wall Plug European Standard Power Adapter</p>	<p><b>PWR-DC1201B-EU</b> UNV DC12V/1A Wall Plug European Standard Power Adapter(Colorful Bag)</p>	<p><b>PWR-DC1201A-IND</b> UNV DC12V/1A Wall Plug Indian Standard Power Adapter-Colorful Bag</p>
		

# Unlimited New View

## Zhejiang Uniview Technologies Co., Ltd.



<http://www.uniview.com>



[overseasbusiness@uniview.com](mailto:overseasbusiness@uniview.com); [globalsupport@uniview.com](mailto:globalsupport@uniview.com)



No. 369, Xietong Road, Xixing Sub-district, Binjiang District, Hangzhou City, 310051, Zhejiang Province, China



©2023-2025 Zhejiang Uniview Technologies Co., Ltd. All rights reserved.

\*Product specifications and availability are subject to change without notice.

Despite our best efforts, technical or typographical errors may exist in this document. Uniview cannot be held responsible for any such errors and reserves the right to change the contents of this document without prior notice.