

2MP + 2MP LightHunter Dual-lens Network PTZ Camera IPC9312LFW-AF28-2X4



Features

- Fixed camera and PTZ camera integration, dual-channel with one IP, provides overall view and detailed view at the same time
- High quality image with 1080P, 1/2.8" CMOS sensor
- 1920 × 1080@25 fps in the main stream
- Ultra 265, H.265, H.264, MJPEG
- 4X optical zoom of PTZ channel allows for closer viewing of subjects
- Smart intrusion prevention, supports false alarm filtering, including cross line, intrusion, enter area, leave area detection
- PTZ channel can be linked to fixed channel's smart intrusion prevention to track the objects triggering the rule
- LightHunter technology ensures ultra-high image quality in low illumination environment
- Up to 120 dB optical WDR (wide dynamic range)
- Built-in dual-mic and high-power speaker, supports two-way audio, has better sound performance
- Supports ceiling mount and wall mount
- IR and warm light illumination to deal with different scenes and achieve full-color illumination
- DC 12 V, PoE+ (IEEE 802.3at) power supply

Specifications

Channel	Channel 1 (Panorama)	Channel 2 (Detail)
Camera		
Sensor	1/2.8" CMOS	
Min. Illumination	Color: 0.002 Lux (F1.6, AGC ON), 0 lux with IR	Color: 0.002 Lux (F1.6, AGC ON), 0 Lux with IR/Warm light
Day/Night	IR-cut filter with auto switch (ICR)	
Shutter	Auto/Manual, 1 to 1/100000 s	
WDR	120 dB	
S/N	>52 dB	
Lens		
Focal Length	2.8 mm	2.8 to 12 mm
Optical Zoom	N/A	4X
Iris	F1.6	
Field of View (H)	102.4°	106.6° to 30.6°
Field of View (V)	54.9°	56.5° to 17.4°
Field of View (D)	133.1°	138.6° to 37.6°
DORI		
DORI Distance (Detect)	43.4 m (142.4 ft.)	43.4 m to 162.9 m (142.4 ft. to 534.5 ft.)
DORI Distance (Observe)	17.4 m (57.1 ft.)	17.4 m to 65.2 m (57.1 ft. to 213.9 ft.)
DORI Distance (Recognize)	8.7 m (28.5 ft.)	8.7 m to 32.6 m (28.5 ft. to 106.9 ft.)
DORI Distance (Identify)	4.3 m (14.1 ft.)	4.3 m to 16.3 m (14.1 ft. to 53.5 ft.)
Video		
Privacy Mask	24 areas, up to 4 areas per scene	
Frame Rate-Main Stream	1080P (1920 × 1080)@25 fps (default) 1080P (1920 × 1080), max. 25 fps 720P (1280 × 720), max. 25 fps	
Frame Rate-Sub Stream	720P (1280 × 720), max. 25 fps D1 (720 × 576), max. 25 fps 640 × 360, max. 25 fps 2CIF (704 × 288), max. 25 fps CIF (325 × 288), max. 25 fps	
Video Compression	Ultra 265, H.265, H.264, MJPEG	
Video Bit Rate	128 Kbps to 16 Mbps	
U-code	Support (main stream)	
ROI	Support	
Video Stream	Dual streams	
OSD	Up to 4 OSDs	
Intelligent		
Linkage Function	Support. Triggered by fixed lens via smart intrusion prevention function to track target	
Smart Intrusion Prevention	Cross line detection, intrusion detection, enter area detection, leave area detection (support)	N/A





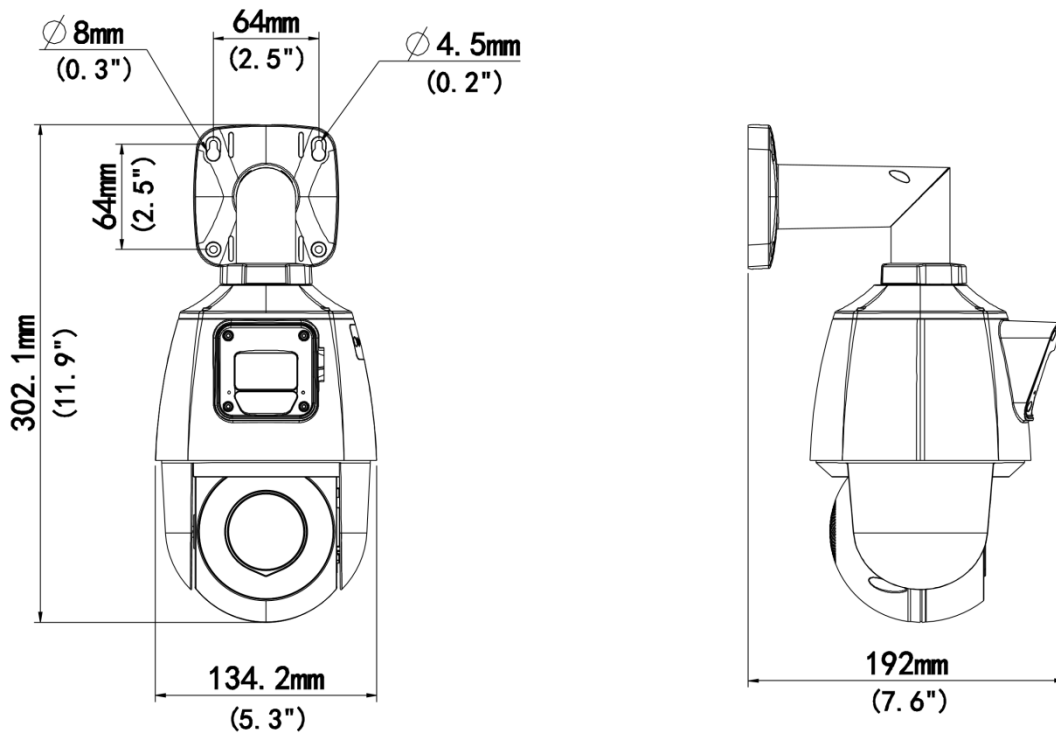

	false alarm filtering and the classification of human, non-motor vehicle and vehicle)	
Image		
White Balance	Auto, Outdoor, Fine tune, Sodium lamp, Locked, Auto2	
Digital Noise Reduction	2D/3D DNR	
Flip	Normal, Flip vertical, Flip horizontal, 180°	
HLC	Support	
BLC	Support	
Smart IR	Support	
Defog	Digital defog	
Illuminator		
Light On/Off Control	Auto/Manual	
Wavelength	850 nm	
Illumination Distance (IR)	10 m (32.8 ft.)	50 m (164.0 ft.)
Illumination Distance (Warm Light)	N/A	10 m (32.8 ft.)
Events		
Basic Detection	Motion detection, Audio detection	
General Function	Watermark, IP address filtering, Access policy, ARP protection, RTSP authentication, User authentication	
Audio		
Audio Compression	G.711U, G.711A	
Audio Bitrate	128 Kbps	
Two-way Audio	Support	
Suppression	Support	
Sampling Rate	16KHz	
Storage		
Edge Storage	MicroSD, up to 512 GB	
Network Storage	ANR, NAS (NFS)	
Network		
Protocols	SSH, IGMP, RTP, RTCP, SMTP, IPv4, IPv6, ICMP, ARP, TCP, UDP, DHCP, PPPoE, RTSP, RTMP, DNS, DDNS, NTP, FTP, UPnP, HTTP, HTTPS, 802.1x, SNMP, QoS, SSL/TLS	
Compatible Integration	ONVIF (Profile S, Profile G, Profile M), API, SDK	
User/Host	Up to 32 users. 3 user levels: administrator, common user and operator	
Security	TLS 1.3, Password Protection, Strong Password, HTTPS Encryption, Export Operation Logs, Basic and Digest Authentication for RTSP, Digest Authentication for HTTP, TLS 1.2, WSSE and Digest Authentication for ONVIF	
Client	EZStation, UNV-Link, UNV-Link Pro	
Web Browser	Plug-in required live view: IE 10+, Chrome 45+, Firefox 52+, Edge 79+	
PTZ		
Number of Presets	N/A	256
Preset Patrol	N/A	16 patrols, up to 64 presets for each patrol
Patrol Stay Time	1000 s to 1800 s	

Home Position	N/A	Support
Pan Range	N/A	0° to 345°
Tilt Range	18°±5°	-10° to 100°
Pan Speed	N/A	1°/s to 40°/s
Tilt Speed	N/A	2°/s to 50°/s
Interface		
Built-in Mic	Built-in dual-mic	
Built-in Speaker	Support	
Network	1 × RJ45 10 M/100 M Base-TX Ethernet	
Certification		
EMC	CE-EMC (EN55032:2015; EN55024:2010+A1:2015; EN61000-3-2:2014; EN61000-3-3:2013) FCC (FCC CFR 47 part15 B, ANSI C63.4-2014)	
Safety	CE LVD (EN 62368-1:2014+A11:2017; EN 62368-1:2014) UL (UL 62368-1, 2nd Ed., Issue Date: 2014-12-01)	
Environment	CE-ROHS (2011/65/EU)	
Protection	IP66 (IEC 60529:1989+AMD1:1999+AMD2:2013)	
General		
Power	DC 12 V, PoE+ (IEEE 802.3at)	
Power Consumption	Max. 16 W	
Power Interface	Ø5.5 mm coaxial power plug	
Dimensions	Wall Mount: 192 mm × 134 mm × 302 mm (7.6" × 5.3" × 11.9") (L × W × H) Ceiling Mount: 154 mm × 134 mm × 363 mm (6.1" × 5.3" × 14.3") (L × W × H)	
Weight	1.03 kg (2.27 lb.)	
Working Environment	-20 °C to 60 °C (-4 °F to 140 °F), Humidity: ≤ 95% RH (non-condensing)	
Storage Environment	-30 °C to 70 °C (-22 °F to 158 °F), Humidity: ≤ 95% RH (non-condensing)	
Surge Protection	2 KV	
Reset Button	Support	
Web Client Language	22 Languages: Traditional Chinese, English, Simplified Chinese, Polish, German, Russian, French, Korean, Dutch, Czech, Portuguese (Europe), Portuguese (Brazil), Japanese, Thai, Turkish, Spanish (Latin America), Spanish (Europe), Hungarian, Italian, Vietnamese, Arabic, Slovak	
Configurable		
P/N		

Dimensions



Accessories

<p>TR-JB07-D-IN Bullet Junction Box(Support wiring from behind)</p>	<p>TR-UP06-B-IN Bullet Pole Mounting Bracket</p>	<p>TR-CM06-D Alarm Ball Machine Hoisting Bracket</p>
		
<p>TR-UC08-C Bullet&Dome Corner Mounting Bracket</p>	<p>TR-A01-IN NPT 3/4" Waterproof Cable Gland</p>	<p>TR-UP06-C-IN Pole Mounting Bracket for Bullet Junction Box Only</p>
		

Unlimited New View

Zhejiang Uniview Technologies Co., Ltd.



<http://www.uniview.com>



overseasbusiness@uniview.com; globalsupport@uniview.com



No. 369, Xietong Road, Xixing Sub-district, Binjiang District, Hangzhou City, 310051, Zhejiang Province, China



©2023-2025 Zhejiang Uniview Technologies Co., Ltd. All rights reserved.

*Product specifications and availability are subject to change without notice.

Despite our best efforts, technical or typographical errors may exist in this document. Uniview cannot be held responsible for any such errors and reserves the right to change the contents of this document without prior notice.