

4MP 5X Wise-ISP Tri-Guard Warm light Network PTZ Camera IPC6314LWH-AX5C-VG2



Features

- High quality image with 4 MP, 1/1.8" CMOS sensor
- Supports ColorHunter with Wise-ISP technology, deeply optimizing color, detail, and smear effects in extremely low-light scenes
- Ultra 265, H.265, H.264, MJPEG
- 2688 × 1520@30 fps in the main stream, 16:9 aspect ratio
- Smart intrusion prevention, supports false alarm filtering, cross line detection, intrusion detection
- 120 dB true WDR meets the image requirements in high-contrast scene
- Built-in mic and speaker
- 40 m (131.2 ft.) warm light distance
- MicroSD, up to 512 GB
- IP66 protection
- DC 12 V, PoE (IEEE 802.3at) power supply

Specifications

Model	IPC6314LWH-AX5C-VG2
Camera	
Sensor	1/1.8" CMOS
Min. Illumination	Color: 0.0005 Lux (F1.2, AGC ON)
Day/Night	IR-cut filter with auto switch (ICR)
Shutter	Auto/Manual, 1 to 1/100000 s
WDR	120 dB
S/N	>56 dB
Lens	
Focal Length	2.7 to 13.5 mm
Optical Zoom	5X
Field of View (H)	113.69° to 50.29°
Field of View (V)	59.46° to 28.45°
Field of View (D)	156.23° to 59.34°
DORI	
DORI Distance (Lens)	2.7 to 13.5 mm
DORI Distance (Detect)	98.6 m to 209.9 m (323.3 ft. to 688.7 ft.)
DORI Distance (Observe)	39.4 m to 84.0 m (129.3 ft. to 275.5 ft.)
DORI Distance (Recognize)	19.7 m to 42.0 m (64.7 ft. to 137.7 ft.)
DORI Distance (Identify)	9.9 m to 21.0 m (32.3 ft. to 68.9 ft.)
Video	
Privacy Mask	Up to 4 areas
Frame Rate-Main Stream	4 MP (2560 × 1440)@25 fps (Default) 4 MP (2688 × 1520), max. 30 fps; 4 MP (2560 × 1440), max. 30 fps;
Video Compression	Ultra 265, H.265, H.264, MJPEG
Video Bit Rate	128 Kbps to 6144 Kbps
U-code	Support
ROI	Support
Video Stream	Triple streams
OSD	Up to 8 OSDs
Intelligent	
Auto Tracking	Support, target filtering: human only
Smart Intrusion Prevention	Support false alarm filtering: cross Line detection, intrusion detection (based on human body and vehicle detection)
Image	
White Balance	Auto, Outdoor, Fine tune, Sodium lamp, Locked, Auto2
Digital Noise Reduction	2D/3D DNR
Flip	Normal, Flip vertical, Flip horizontal, 180°
HLC	Support
BLC	Support



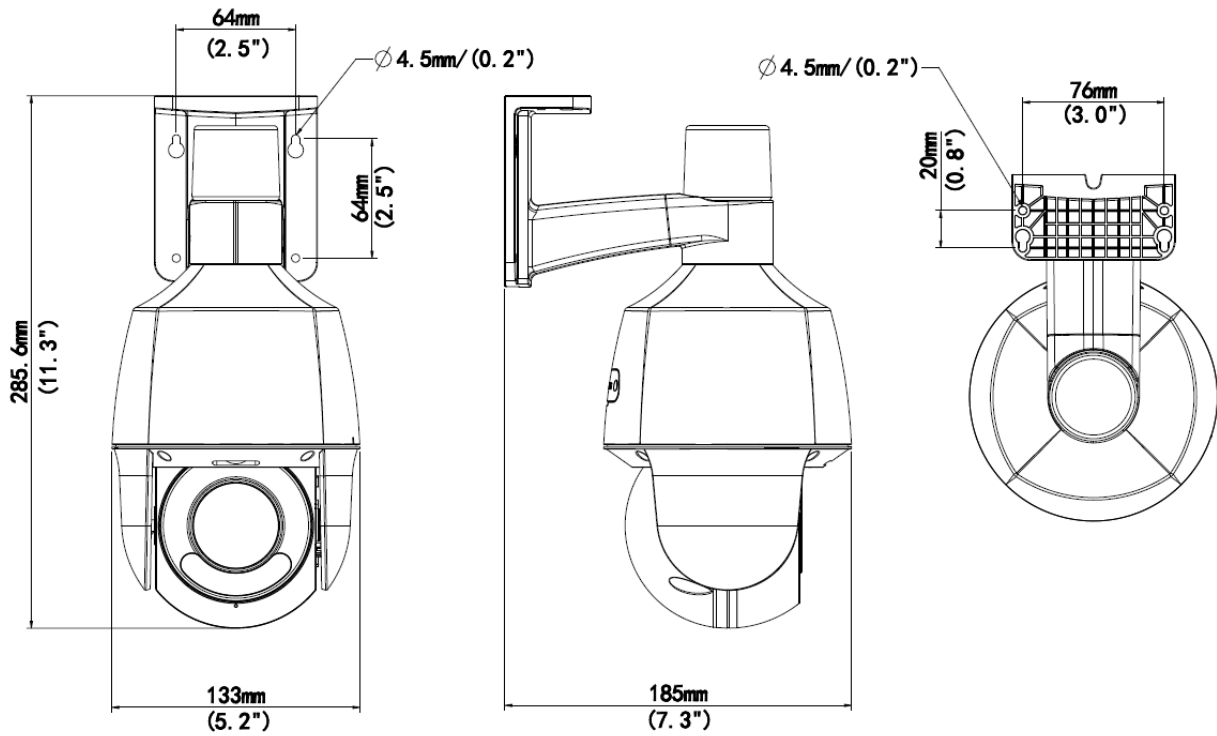

Defog	Digital defog
Illuminator	
Light On/Off Control	Auto/Manual
Illumination Distance (Warm Light)	40 m
Events	
Basic Detection	Motion detection, Audio detection, Tampering alarm
Motion Detection	Support
Tampering Detection	Support
Audio Detection	Support
General Function	Watermark, IP address filtering, Access policy, ARP protection, RTSP authentication, User authentication
UMD (Ultra Motion Detection)	Support
Audio	
Audio Compression	G.711U, G.711A
Audio Bitrate	128 Kbps
Two-way Audio	Support
Suppression	Support
Sampling Rate	8 kHz, 16 kHz
Storage	
Edge Storage	MicroSD, up to 512 GB
Network Storage	ANR, NAS (NFS)
Network	
Protocols	TLS1.3, SSH, IGMP, RTP, RTCP, SMTP, IPv4, IPv6, ICMP, ARP, TCP, UDP, DHCP, PPPoE, RTSP, RTMP, DNS, DDNS, NTP, FTP, UPnP, HTTP, HTTPS, 802.1x, SNMP, QoS, SSL/TLS
Compatible Integration	ONVIF (Profile S, Profile G, Profile T), API
Security	Password Protection, Strong Password, HTTPS Encryption, Export Operation Logs, Basic and digest authentication for RTSP, Digest authentication for HTTP, TLS 1.2, WSSE and digest authentication for ONVIF
Client	EZStation, EZLive, EZView
Web Browser	Plug-in required live view: IE 10 and above, Chrome 45 and above, Firefox 52 and above, Edge 79 and above
PTZ	
Number of Presets	1024
Preset Patrol	16 patrols, up to 64 presets for each patrol
Patrol Stay Time	120 s to 1800 s
Home Position	Support
Number of Presets (IPC)	1024
Pan Range	0° to 345°
Tilt Range	-10° to 100°
Pan Speed	1°/s to 50°/s
Tilt Speed	1°/s to 40°/s
Number of Patrol	16

Interface	
Audio I/O	1 Input: impedance 1 k Ω , amplitude 2.5 V [p-p], 1 Output: impedance 600 Ω , amplitude 2.5 V [p-p]
Alarm I/O	1/1
Built-in Mic	Support
Built-in Speaker	Support
Network	1 \times RJ45 10 M/100 M Base-TX Ethernet
Certification	
EMC	CE-EMC (EN 55032; EN IEC 61000-3-2; EN 61000-3-3; EN 50130) FCC SDoC (47 CFR Part 15; Subpart B)
Safety	UL (UL 62368-1) CUL (CAN/CSA C22.2 No. 62368-1) CE-LVD (EN IEC 62368-1)
Environment	CE-ROHS (2011/65/EU;(EU)2015/863)
Protection	IP66 (IEC 60529)
General	
Power	DC 12 V \pm 25%, PoE (IEEE 802.3at)
Power Consumption	\leq 25.4 W
Dimensions	185 mm \times 133 mm \times 286 mm (7.3" \times 5.2" \times 11.3") (L \times W \times H)
Weight	0.84 kg (1.85 lb.)
Working Environment	-30 $^{\circ}$ C to 60 $^{\circ}$ C (-22 $^{\circ}$ F to 140 $^{\circ}$ F), Humidity: \leq 95% RH (non-condensing)
Storage Environment	-40 $^{\circ}$ C to 70 $^{\circ}$ C (-40 $^{\circ}$ F to 158 $^{\circ}$ F), Humidity: \leq 95% RH (non-condensing)
Surge Protection	2 KV
Reset Button	Support
Material	Plastic
Heater	Support
Web Client Language	22 Languages: Traditional Chinese, English, Simplified Chinese, Polish, German, Russian, French, Korean, Dutch, Czech, Portuguese (Europe), Portuguese (Brazil), Japanese, Thai, Turkish, Spanish (Latin America), Spanish (Europe), Hungarian, Italian, Vietnamese, Arabic, Slovak
Live View	
Maximum Bitstream	35
OSD Color	Support
OSD Character Number	40

Dimensions

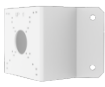

Accessories

<p>TR-JB07-D-IN Bullet Junction Box(Support wiring from behind)</p>	<p>TR-CM06-D Alarm Ball Machine Hoisting Bracket</p>	<p>TR-A01-IN NPT 3/4" Waterproof Cable Gland</p>
		
<p>TR-UP06-B-IN Bullet Pole Mounting Bracket</p>	<p>TR-UP06-C-IN-V2 Pole Mounting Bracket for Bullet Junction Box Only</p>	<p>TR-UC08-C-V2 Bullet&Dome Corner Mounting Bracket</p>
		

Unlimited New View

Zhejiang Uniview Technologies Co., Ltd.

 <http://www.uniview.com>

 overseasbusiness@uniview.com; globalsupport@uniview.com

 No. 369, Xietong Road, Xixing Sub-district, Binjiang District, Hangzhou City, 310051, Zhejiang Province, China



©2023-2025 Zhejiang Uniview Technologies Co., Ltd. All rights reserved.

*Product specifications and availability are subject to change without notice.

Despite our best efforts, technical or typographical errors may exist in this document. Uniview cannot be held responsible for any such errors and reserves the right to change the contents of this document without prior notice.